

# TRIUMPH

*A catalogue of famous Motor Cycles*



# Introduction

FOR over thirty-seven years without a break, this factory has been producing good motor cycles. Following the policy of the Company to produce only the highest quality class of machine, the range described in this catalogue represents the traditional excellence of Triumph manufacture applied to modern design.

The confidence we have earned with the motor cycle public was amply demonstrated by the unprecedented and immediate popularity of the "Tiger" models, when they were introduced last year. All the characteristics of these excellent machines, which appeal to the sporting rider, have been retained and a great number of improvements and technical developments introduced.

Secure in the knowledge that every Triumph model, in addition to its attractive appearance and absolute reliability, is sterling value for money, we look forward with confidence to yet another successful year for Triumph.

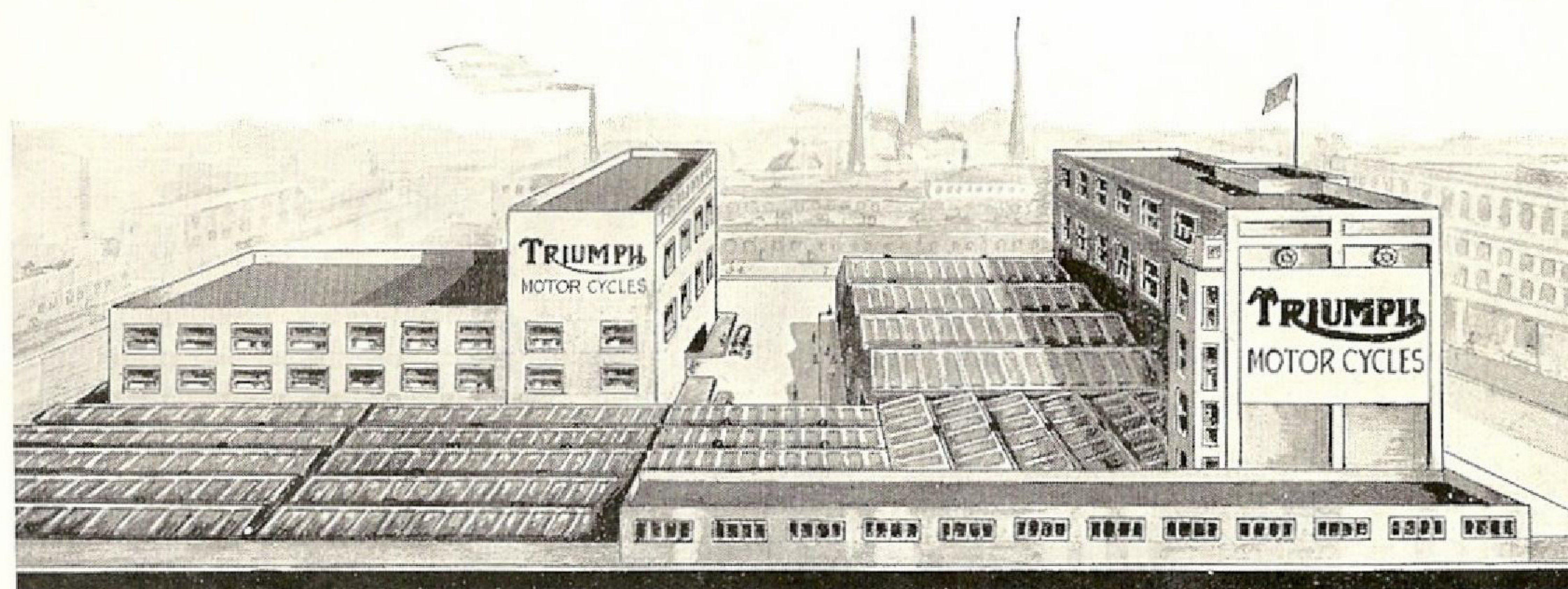

## 1937 Models and Prices

<b>TIGER 90</b> (500 c.c. O.H.V.)	....	....	£66
<b>TIGER 80</b> (350 c.c. O.H.V.)	....	....	£57
<b>TIGER 70</b> (250 c.c. O.H.V.)	....	....	£52
<b>DE LUXE 6S</b> (600 c.c. S.V.)	....	....	£57
<b>DE LUXE 5H</b> (500 c.c. O.H.V.)	....	....	£59
<b>DE LUXE 3H</b> (350 c.c. O.H.V.)	....	....	£53
<b>DE LUXE 3S</b> (350 c.c. S.V.)	....	....	£52
<b>DE LUXE 2H</b> (250 c.c. O.H.V.)	....	....	£48

*Above prices include Lucas 6 volt Magdyno Lighting with voltage control, large Headlamp and an Electric Horn.*

*Smith Chronometric Speedometer is an extra at £2 10. Tiger "90" (120 m.p.h.) £2 16.*

TRIUMPH ENGINEERING CO. LTD  
COVENTRY ENGLAND

Telephone  
Coventry 60021 (7 lines)

Telegrams & Cables  
"Trusty" Coventry

Codes—A.B.C. 5th Edition Bentleys Marconi

Contractors to H.M. Government, Crown Colonies,  
Overseas Governments and Municipal Authorities.



# GENERAL SPECIFICATION

## "TIGER" MODELS

- ENGINE :** Single-port O.H.V. high efficiency units of advanced design, individually tuned and Heenan & Froude brake-tested, dismantled, inspected and re-assembled by expert mechanics. All-gear drive to magdyno, hardened, tempered and highly finished cylinder barrel, adequately finned. Cylinder head of efficient design, highly polished to correct contour, piston of special alloy—choice of high or low compression.
- CRANKCASE :** High tensile aluminium alloy, internally webbed with magneto platform cast integrally with timing case.
- FLYWHEELS :** High tensile forged steel with polished peripheries. Mainshafts mounted on large diameter ball-bearings.
- CONNECTING ROD:** Nickel chrome stamping of light stiff construction, polished all over.
- BIG END :** Large diameter double roller bearing.
- VALVE SPRINGS:** Duplex Aero Quality.
- LUBRICATION :** Full dry-sump system, incorporating accessible double plunger pump with positive feed to big end. Overhead enclosed valve gear with automatic lubrication to rockers and valve guides. Long wear and mechanical silence. Oil gauge in instrument panel.
- CARBURETTER:** Large bore Amal. Quick action twist grip control.
- PETROL TANK :** All-steel welded, new Triumph design, combining shapely streamline contour with large capacity. Flush rubber mounted instrument panel comprising oil gauge, ammeter, switch and dash lamp. Quick opening filler cap. Capacity: Tiger "90": 3½ galls. Tiger "80": 3 galls. Tiger "70": 2½ galls.
- OIL TANK :** All-steel welded with accessible filters and separate vent: capacity ¾ gall.
- FRAME :** Entirely redesigned. Brazed full cradle type, from tubes of finest alloy steel combining immense strength with lightness and even weight distribution. Large diameter tapered front down tube. A correct riding position with the highest possible standard of road holding at speed is secured.
- FRONT FORKS** Taper tube girder, incorporating dampers on the lower bridge. Hand adjustment.
- GEARBOX :** Four-speed all-Triumph design and manufacture. Gears and shafts of nickel-chrome steel of Triumph accuracy and precision. Large multi-plate clutch, patented positive stop foot change.
- TRANSMISSION:** Primary chain running in polished cast aluminium oil bath. Rear chain adequately protected.
- BRAKES :** Redesigned. 7" diameter brakes (special alloy detachable ribbed drums to Tiger "90") with extra wide shoes. Powerful and smooth braking with long life. Finger adjustment. Front Brake adjustment accessible from Saddle.
- SADDLE :** De luxe soft top type, adjustable for height.
- HANDLEBAR :** Triumph, resiliently mounted, eliminating fatigue and shocks, full range of adjustment provided. Control levers grouped and adjustable to suit individual requirements. T.T. type brake and clutch levers.
- MUDGUARDS :** Of adequate width with streamline section stays. Detachable tail piece to facilitate rear wheel removal.
- WHEELS & TYRES :** New Triumph wheels with spokes of approximately equal length taking braking and transmission stresses. Dunlop tyres.  
Tiger "90": { rear: 26" x 3.5" Universal.  
                  front: 26" x 3" Ribbed.  
Tiger "80": { rear: 26" x 3.25" Universal.  
                  &"70": { front: 26" x 3" Ribbed.
- TOOLBOX :** Large capacity and water-tight. All steel construction; rubber sealed. Complete set of good quality tools, grease gun and instruction booklets.
- FINISH & EQUIPMENT :** Petrol tank finished in chromium plate, panelled in silver sheen, lined out in Blue. Mudguards Black with silver sheen centre strip lined out in blue. Spokes and rims chromium plate, rim centres in silver sheen, lined out in blue. Specially shaped knee grips for comfort and security at high speeds. Lucas 6-volt magdyno lighting with voltage control, 8" diameter chromium plated, anti-glare head lamp. Altette horn. Chromium plated upswept or downswept exhaust pipe to choice. All aluminium parts smooth and highly polished and both chromium plate and enamel of the highest quality.



# TRIUMPH

## TIGER "70"

63 mm. by 80 mm.  
250 c.c. O.H.V.

### £52

*Including Lucas 6-volt Magdyno  
Lighting Set with automatic volt-  
age control and electric horn.*

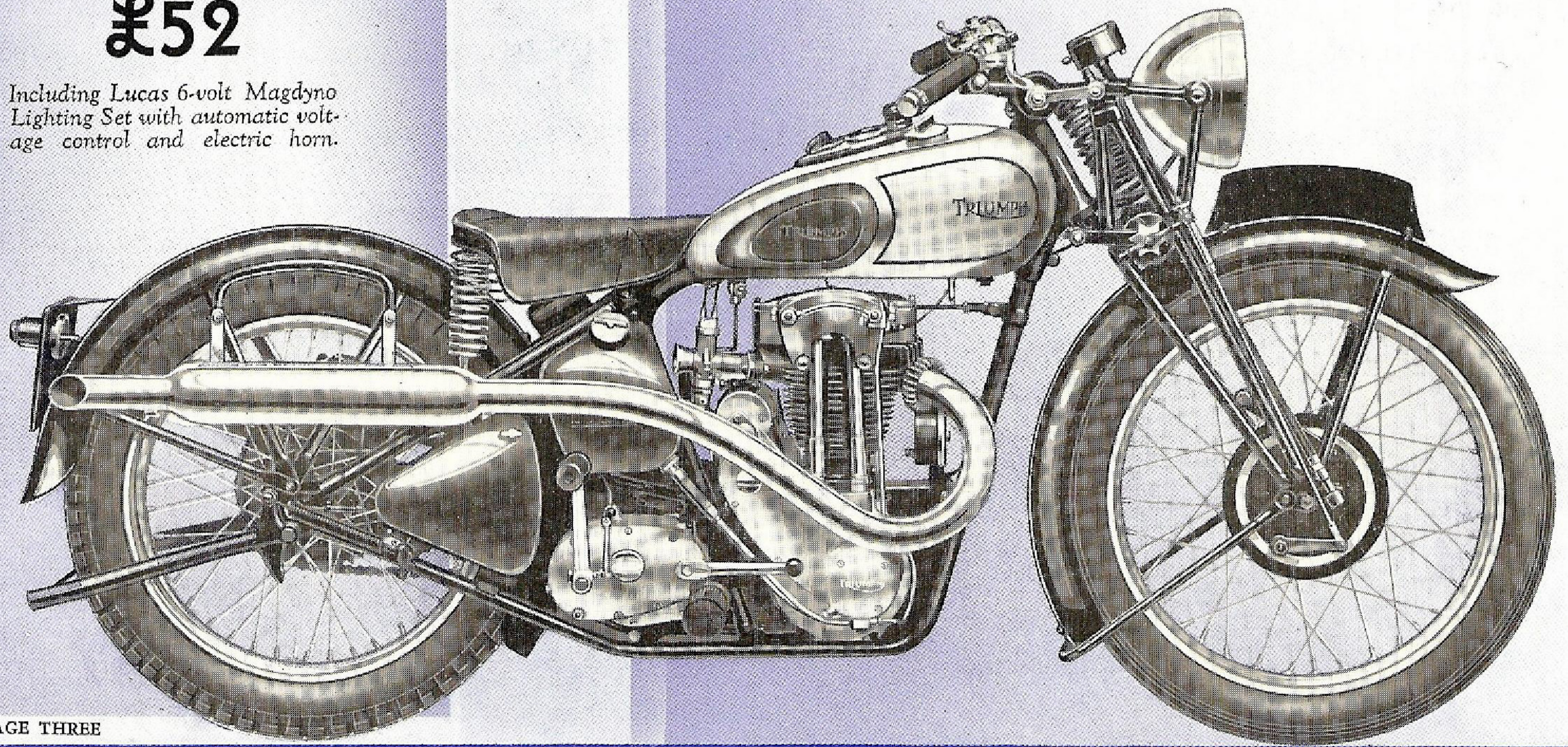



# TRIUMPH

## TIGER "80"

70 mm. by 89 mm.  
350 c.c. O.H.V.

### £57

*Including Lucas 6-volt Magdyno  
Lighting Set with automatic volt-  
age control and electric horn.*

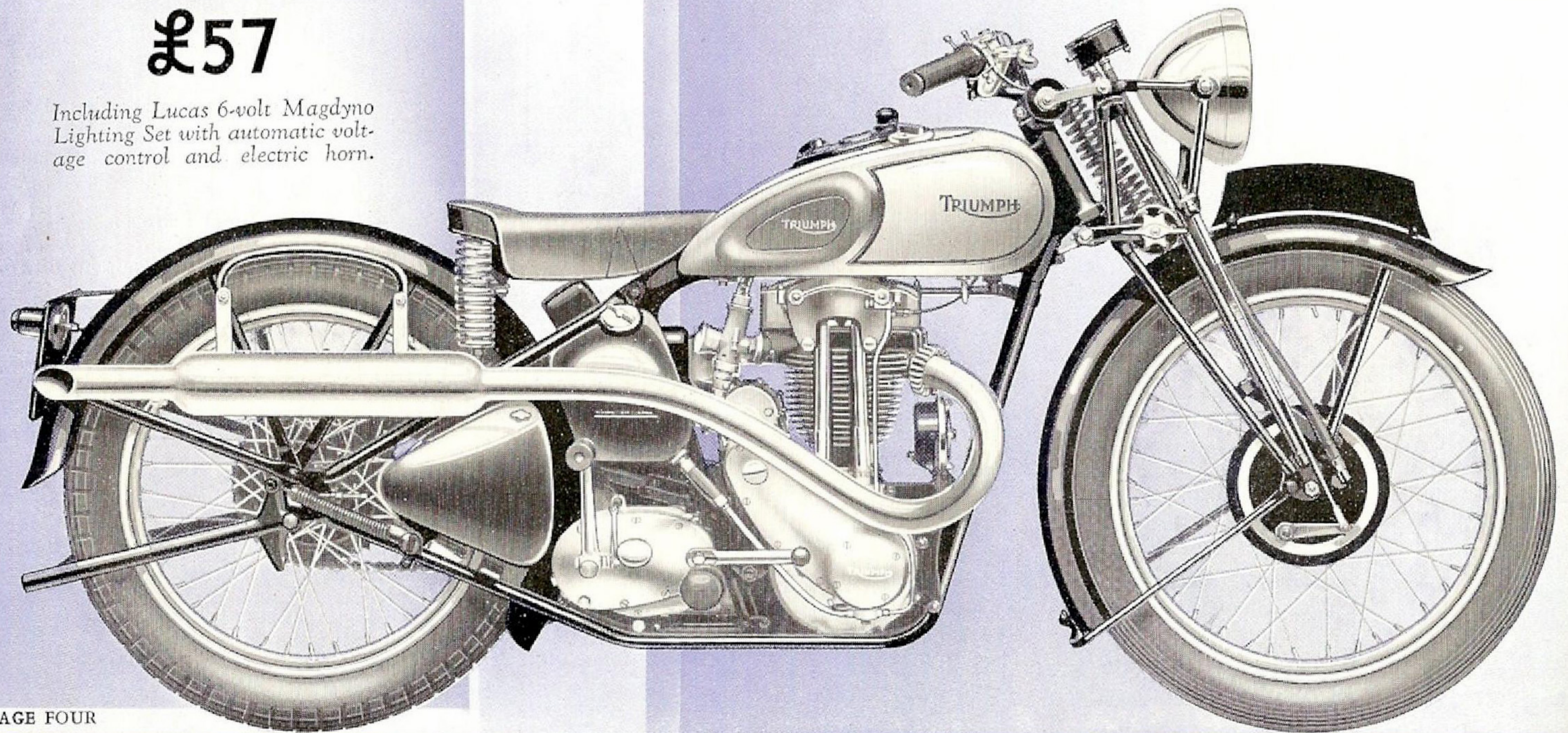



# TRIUMPH

## TIGER "90"

84 mm. by 89 mm.  
500 c.c. O.H.V.

### £66

*Including Lucas 6-volt Mag lyno  
Lighting Set with automatic volt-  
age control and electric horn.*

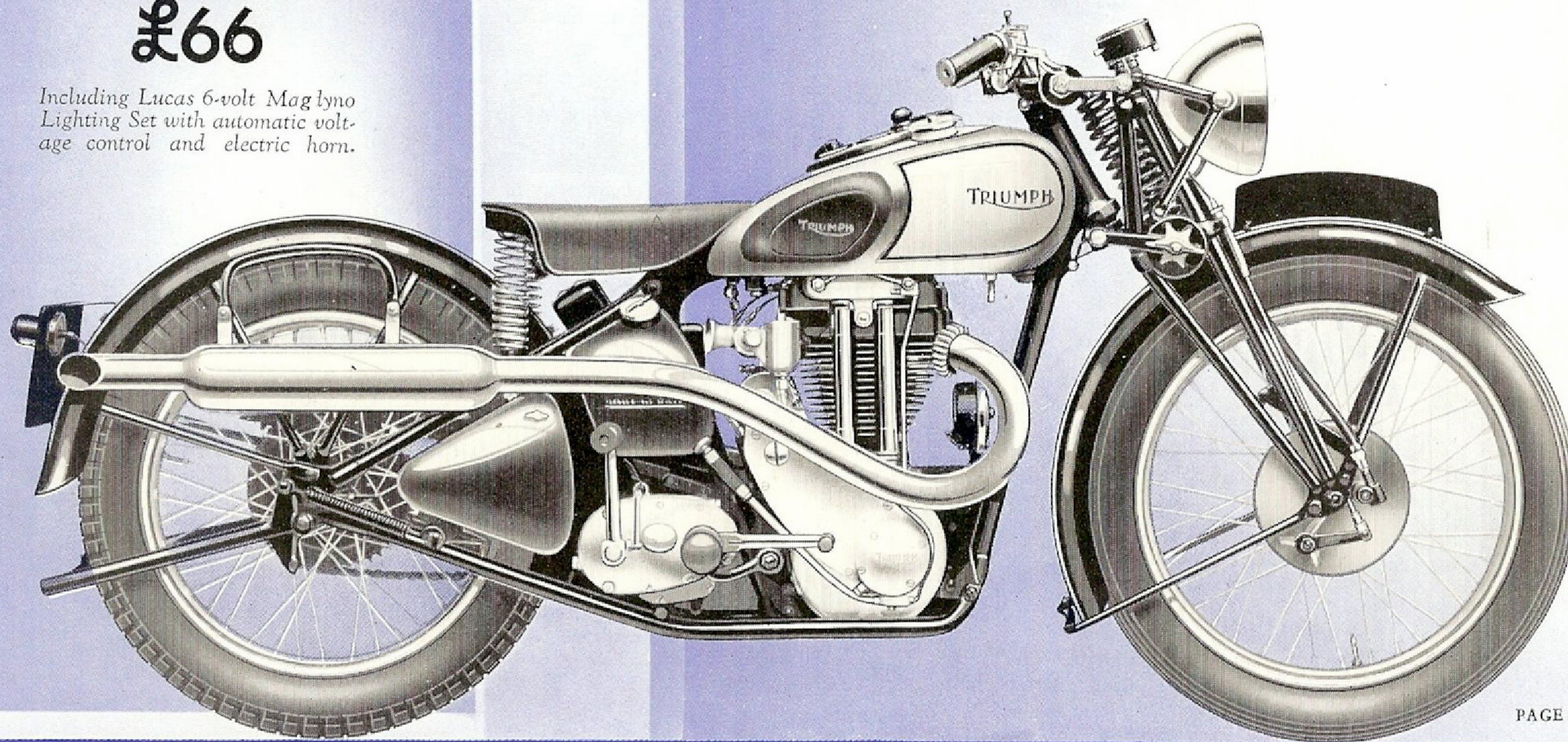



# GENERAL SPECIFICATION

## "DE LUXE" MODELS

- ENGINE :** Models 5H, 3H and 2H. Single port O.H.V. units of advanced design. Gear driven magdyno. Heavily finned cylinder barrel and head. Piston of special low expansion aluminium alloy. Models 6S and 3S. Detachable cylinder head. Combustion chamber of the latest non-pinking internal formation. Gear driven magdyno.
- CRANKCASE :** Aluminium alloy heavily webbed internally. Magneto platform cast integrally with timing case.
- CRANKSHAFT :** Of substantial size, mounted in large diameter ball bearings.
- CONNECTING ROD :** Nickel chrome stamping combining great strength with lightness. Double roller bearing big end.
- VALVE SPRINGS :** Aero Quality. Duplex Springs on O.H.V. models
- LUBRICATION :** Full dry sump system. Valve gear fully enclosed and automatically lubricated. Double plunger oil pump with positive feed to big end. Oil gauge in panel. Oil tank capacity :  $\frac{3}{4}$  gallon.
- CARBURETTER :** Large bore Amal.
- PETROL TANK :** All steel welded of shapely streamline contour and of large capacity. Rubber mounted illuminated instrument panel with oil gauge, ammeter, switch and dash lamp.  
Capacity :  
5H and 6S models —  $3\frac{1}{4}$  gallons.  
3H — 3 gallons.  
3S and 2H —  $2\frac{3}{4}$  gallons.  
Specially shaped knee grips to ensure comfort and security under all conditions.
- FRAME :** Full cradle type, with single large diameter front down tube, combining great strength and torsional stiffness with low weight. Excellent weight distribution is afforded and the road holding at speed is of the highest possible standard.
- FRONT FORKS :** Taper tube girder type with hand adjustable rebound dampers on lower bridge.
- GEARBOX :** Four speed Triumph gearbox with totally enclosed positive stop foot change. Gears and shafts of nickel chrome steel. Multi-plate clutch operated by a new and entirely enclosed mechanism.
- TRANSMISSION :** Primary chain enclosed in handsome cast aluminium oil bath case with accessible filler and drain plugs.
- BRAKES :** Of greatly improved design. 7" diameter with finger adjusters. Front brake adjustment accessible from the saddle.
- SADDLE :** De luxe flexible top.
- HANDLEBAR :** Resiliently mounted. Grouped control levers with T.T. type brake and clutch levers. All controls fully adjustable.
- WHEELS AND TYRES :** New Triumph wheels of improved design. Dunlop Tyres.
- |     | Front.    | Rear.     |
|-----|-----------|-----------|
| 6S. | 26 x 3.25 | 26 x 3.25 |
| 5H. | 26 x 3.25 | 26 x 3.25 |
| 3H. | 26 x 3.25 | 26 x 3.25 |
| 3S. | 26 x 3.25 | 26 x 3.25 |
| 2H. | 26 x 3.0  | 26 x 3.25 |
- Effective mudguards of substantial D Section and adequate width. Detachable tail piece to rear guard. Streamlined section stays.
- TOOLBOX :** All steel with rubber sealed lid, water-tight. Of large capacity. Complete set of tools, grease gun and instruction book.
- FINISH AND EQUIPMENT.** Petrol tank in chromium plate panelled in plum lined out in gold. All aluminium parts highly polished. Frame, mudguards and wheels finished in 3 coats of best black enamel. Upswept Exhaust Pipe optional on O. H. V. models. Lucas 6-volt magdyno lighting with voltage control, large diameter Head Lamp and Electric Horn. Chromium plated exhaust system with tubular silencer.



# TRIUMPH

## DE LUXE 6S

84 mm. by 108 mm.  
600 c.c. S.V.

### £57

*Including Lucas 6-volt Magdyno  
Lighting Set with automatic volt-  
age control and electric horn.*

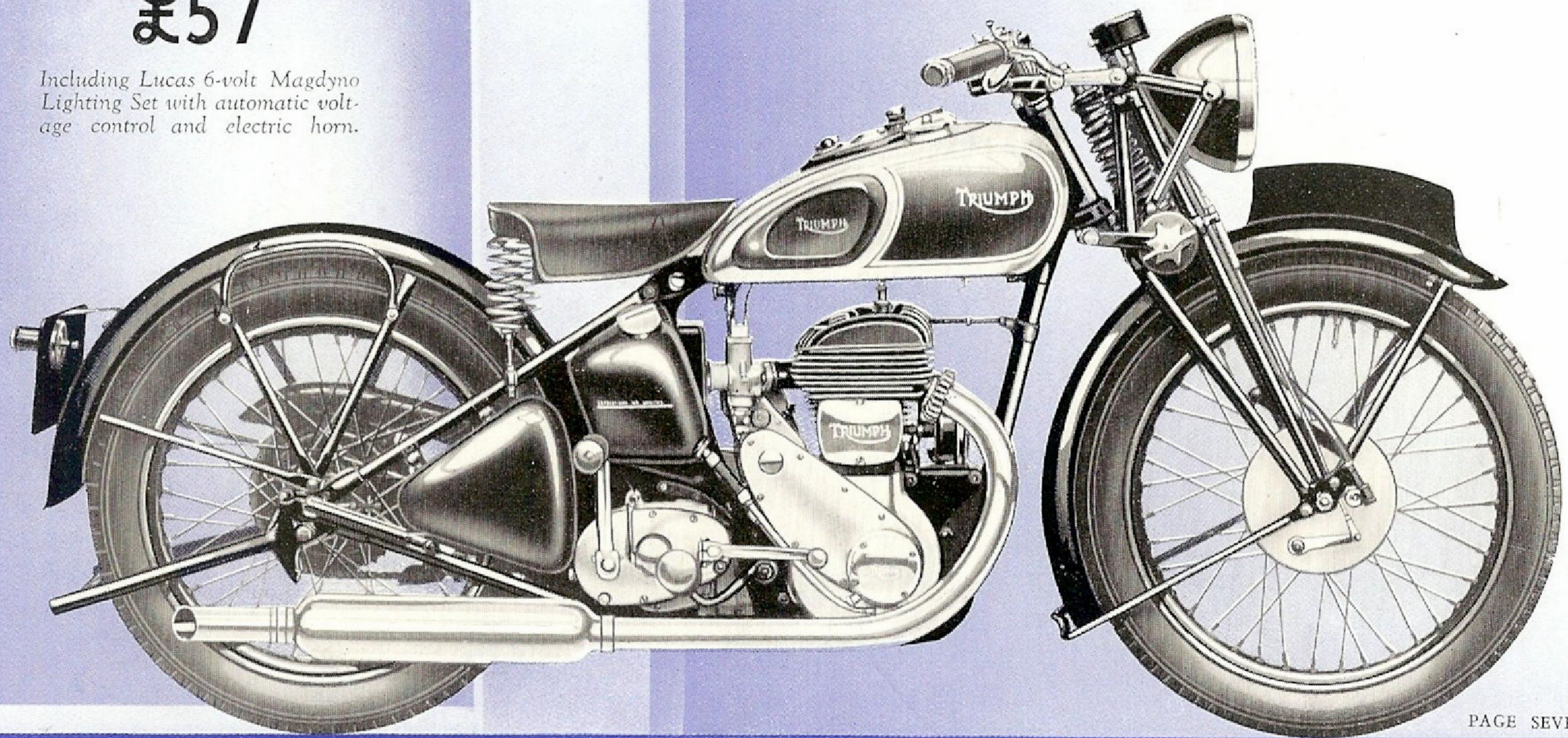

PAGE SEVEN



# TRIUMPH

## DE LUXE 5H

84 mm. by 89 mm.  
500 c.c. O.H.V.

### £59

*Including Lucas 6-volt Magdyno  
Lighting Set with automatic volt-  
age control and electric horn.*

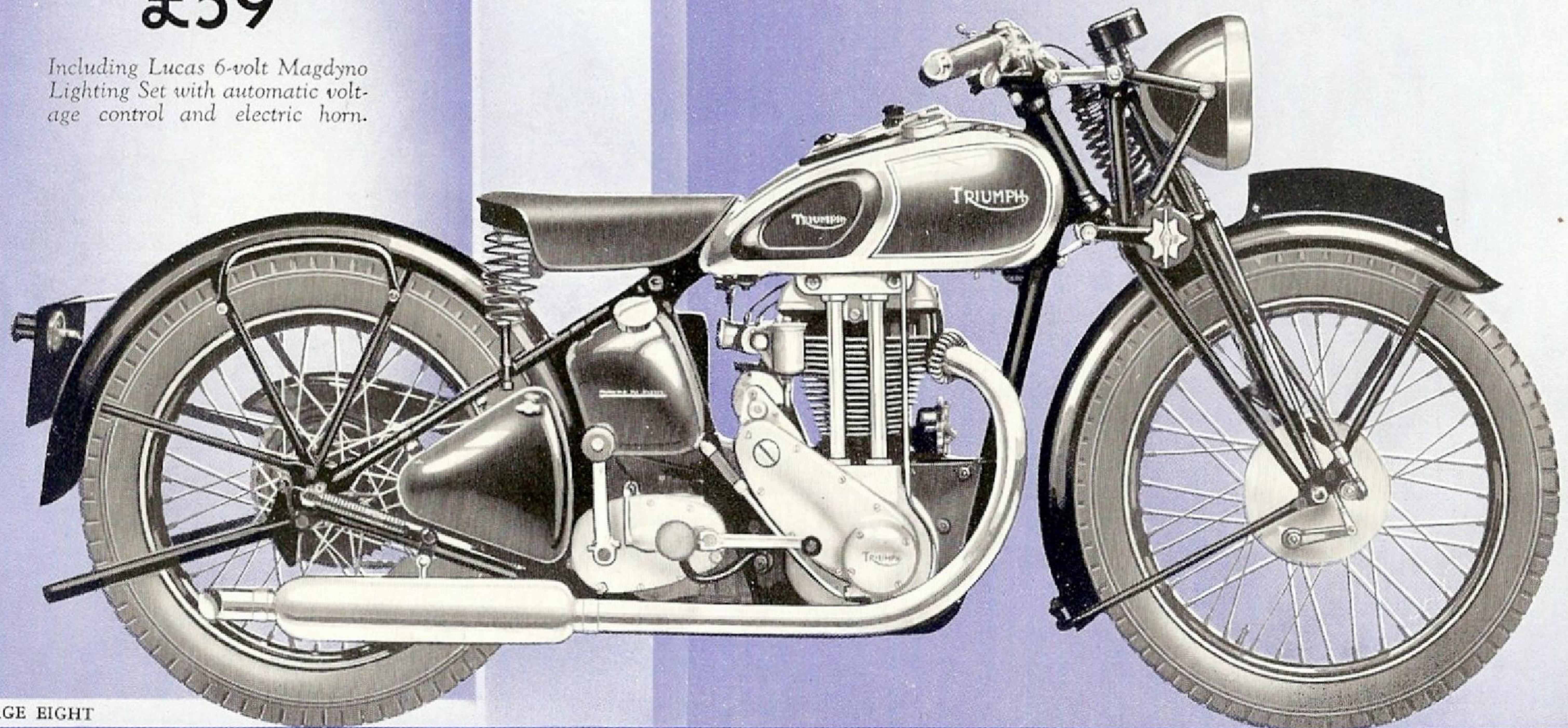



# TRIUMPH

## DE LUXE 3H

70 mm. by 89 mm.  
350 c.c. O.H.V.

### £53

*Including Lucas 6-volt Magdyno  
Lighting Set with automatic volt-  
age control and electric horn.*

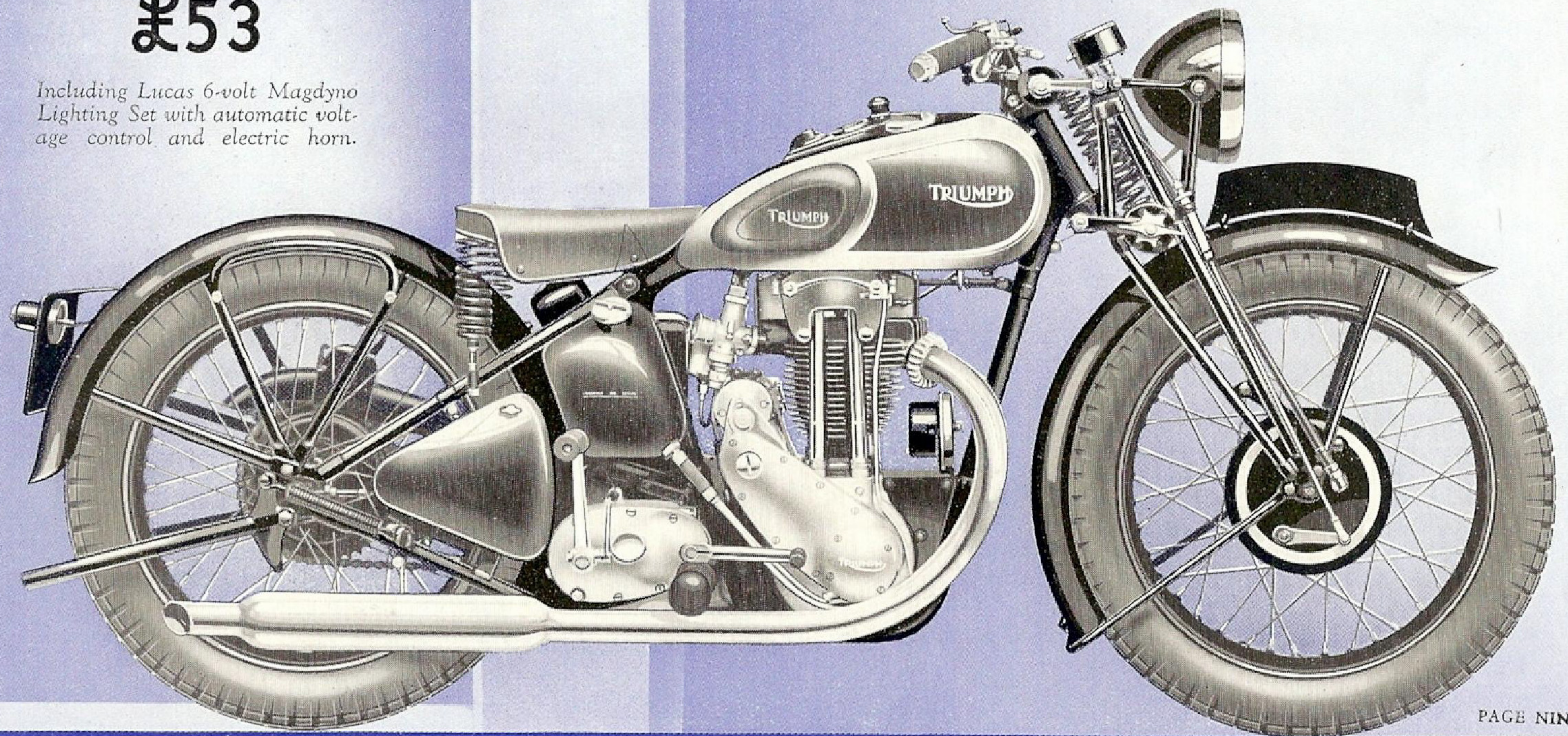

PAGE NINE



# TRIUMPH

## DE LUXE 3S

70 mm. by 89 mm.  
350 c.c. S.V.

### £52

*Including Lucas 6-volt Magdyno  
Lighting Set with automatic volt-  
age control and electric horn.*

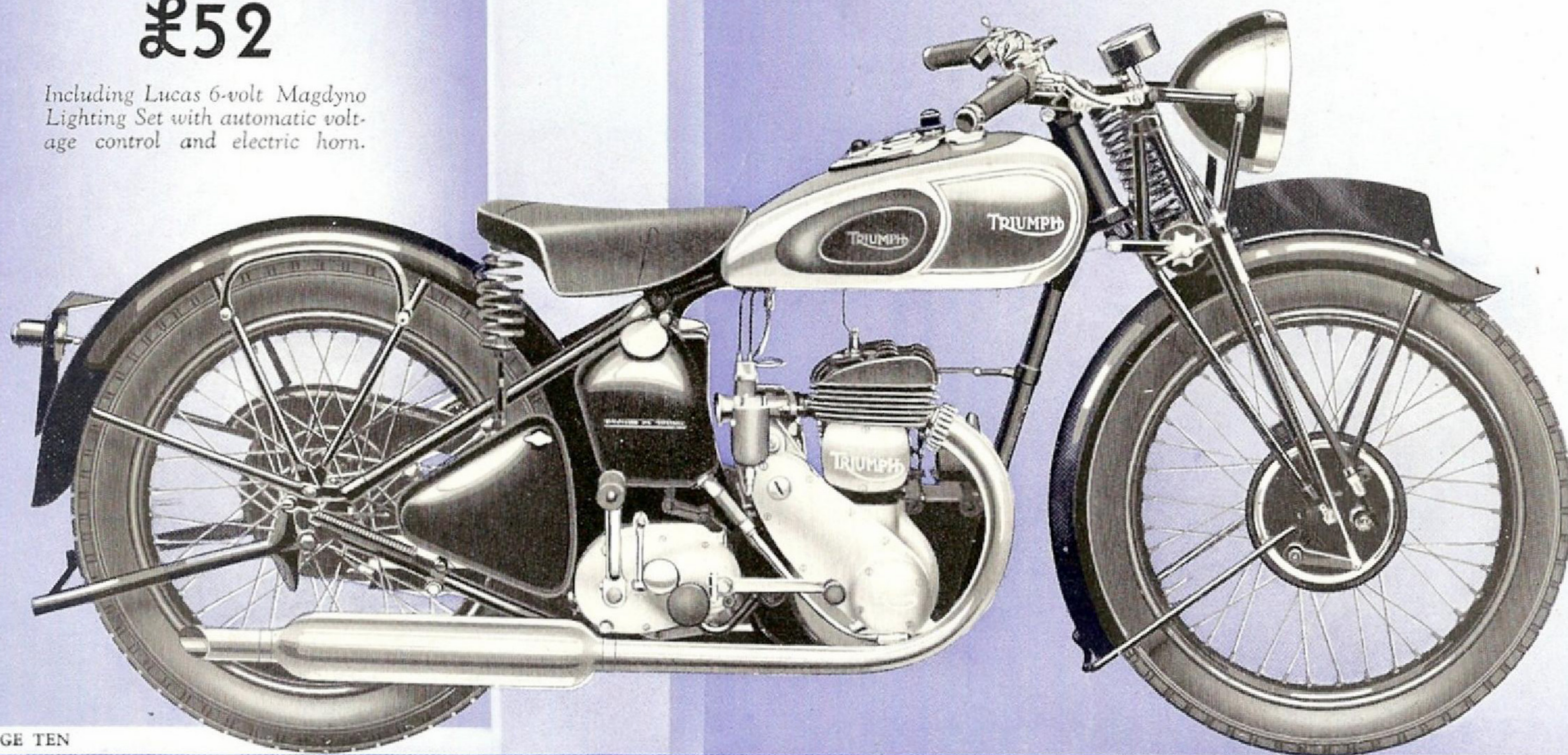

PAGE TEN



# TRIUMPH

## DE LUXE 2H

63 mm. by 80 mm.  
250 c.c. O.H.V.

### £48

*Including Lucas 6-volt Magdyno  
Lighting Set with automatic volt-  
age control and electric horn.*

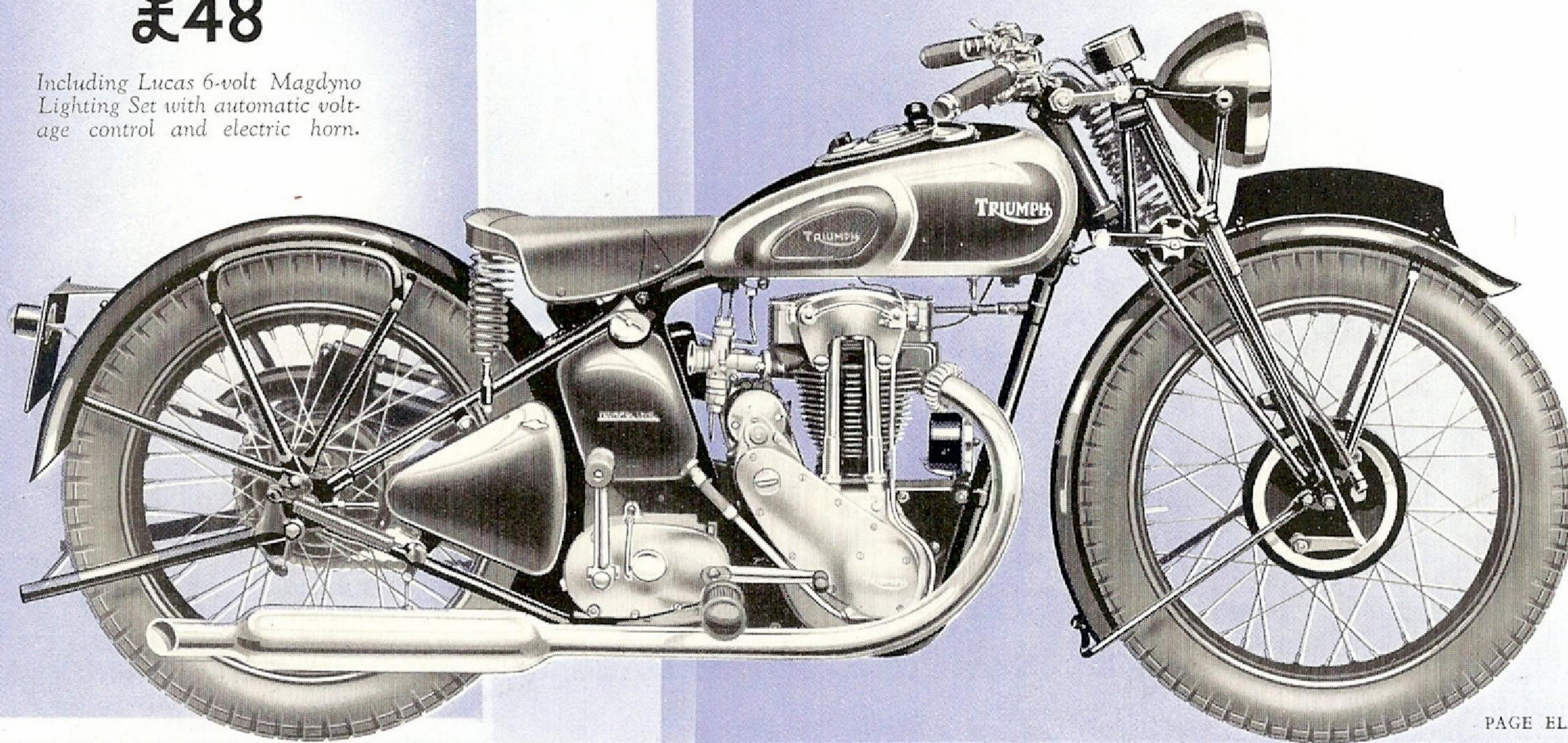

PAGE ELEVEN



# TRIUMPH SIDECARS

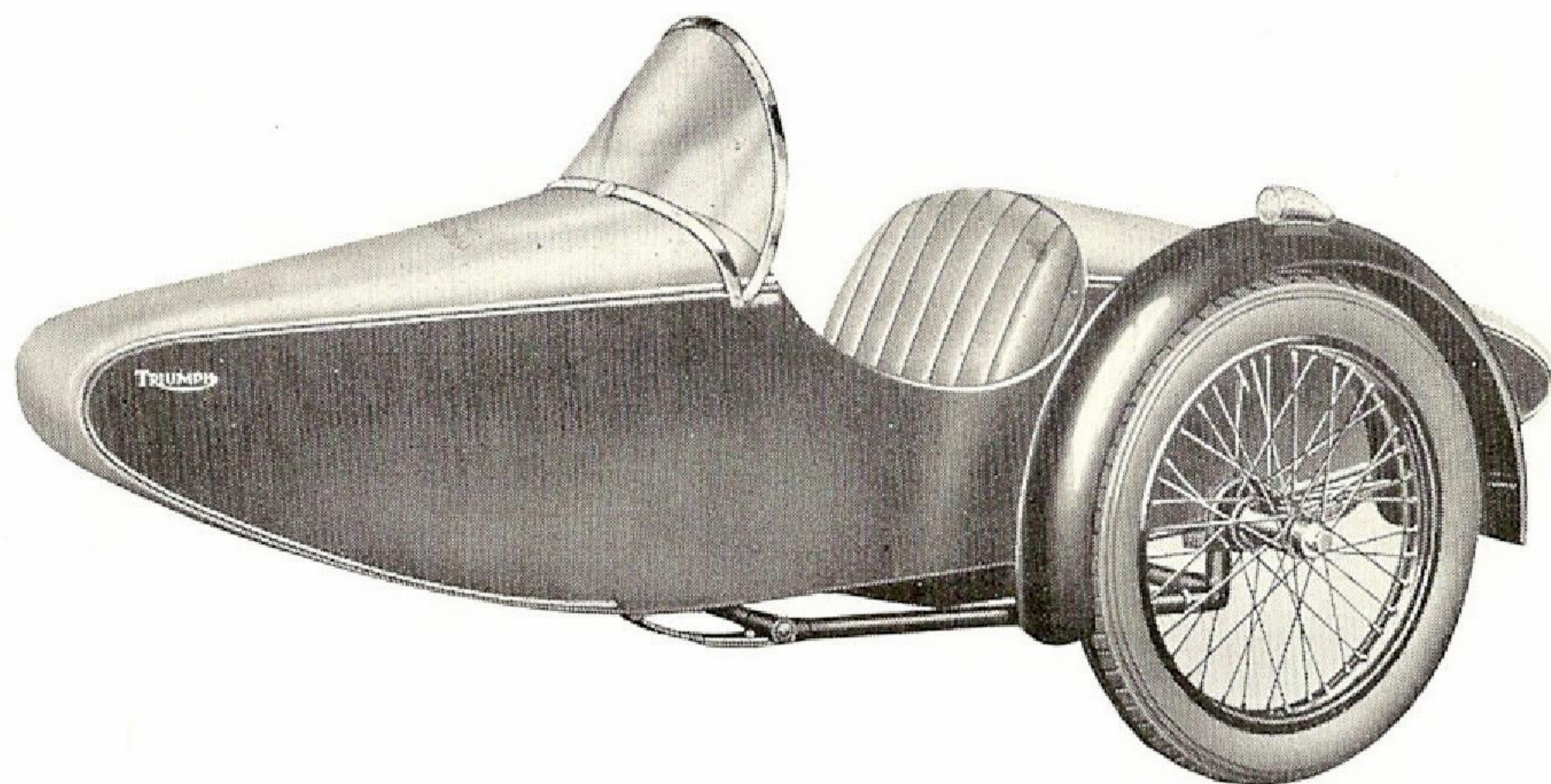

## Model SS/37

A most attractive coachbuilt Sports Sidecar of pleasing streamline contour. Of exceptionally strong but light construction. Strongly designed tubular chassis of heavy gauge, weldless steel. All lugs brazed-up. Fittings include, windscreen with chromium plated frame, best quality leather cloth upholstery and cover-all apron. Colours: Plum and Black or Blue and Silver.

PRICE (complete with Lucas electric lamp) **£17-10-0**

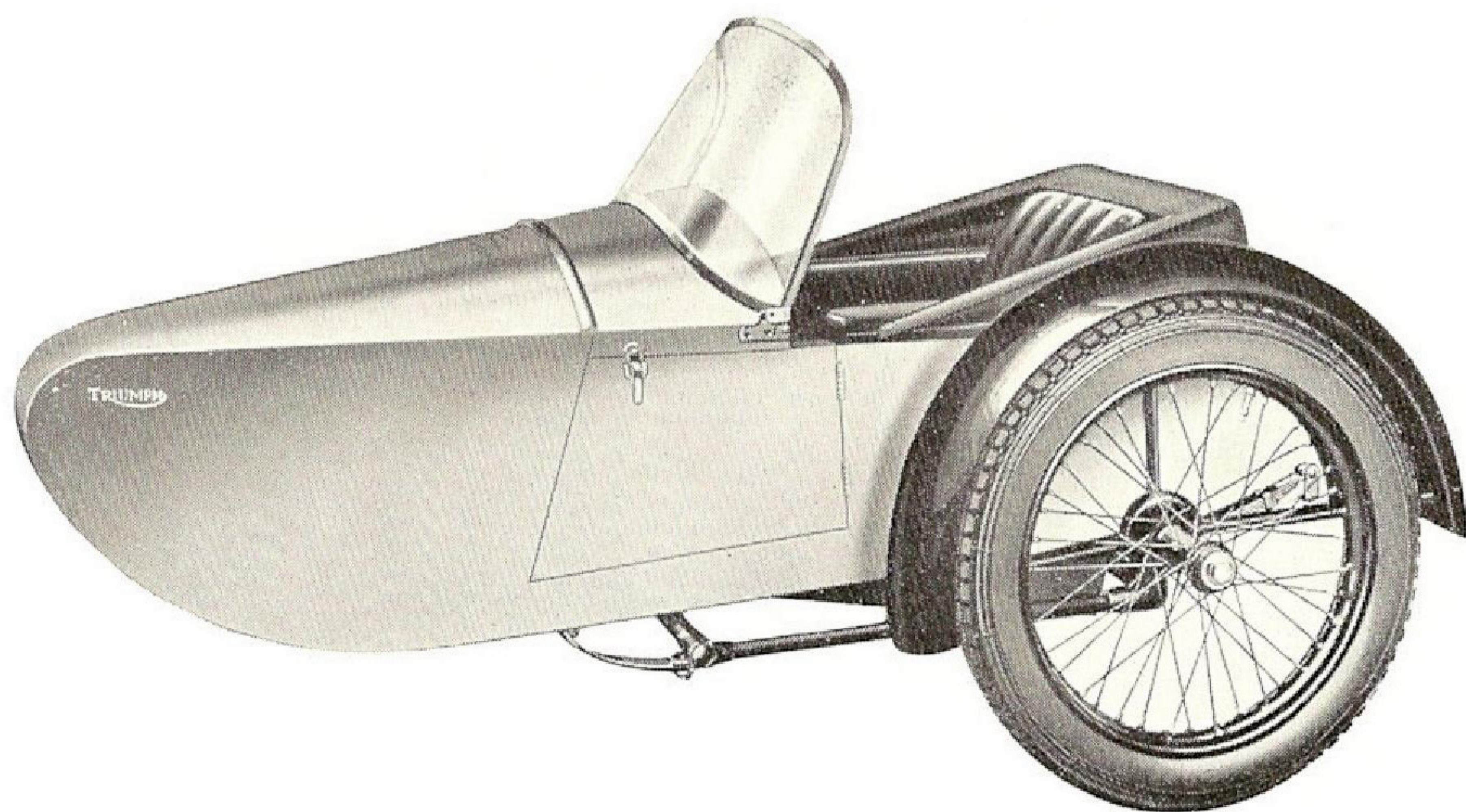

## Model AT/37

An all-weather Touring Sidecar of modern design which makes its own appeal to those in need of a sidecar for long distance touring. Chassis as for Model SS/37. Fittings include, hinged scuttle with efficient windscreen with chrome frame, best quality leather cloth upholstery deeply sprung, and efficient hood. Colours: Plum and Black or Blue and Silver.

PRICE (complete with Lucas electric lamp) **£18-15-0**

ALL TRIUMPH SIDECAR CHASSIS ARE ATTACHED TO THE MACHINE BY MEANS OF SELF-ALIGNING BALL JOINTS



# TRIUMPH SIDECARS

## Model ST/37

An extremely attractive luxury Touring Sidecar, with distinctive sweeping lines and interior roominess. Note the deep louvres, water tight hinged scuttle and large door. The body is quickly convertible for all-weather touring and embodies a dickey seat. Strong, heavy gauge weldless tubular steel chassis, specially sprung at rear, lugs brazed-up. Fittings include, hinged scuttle, windscreen with chrome frame of new design with chrome framed sidescreens. Best quality leather cloth upholstery, deeply sprung. New type hood. Colours: Plum and Black or Blue and Silver.

PRICE (complete with Lucas electric lamp)

**£22-5-0**

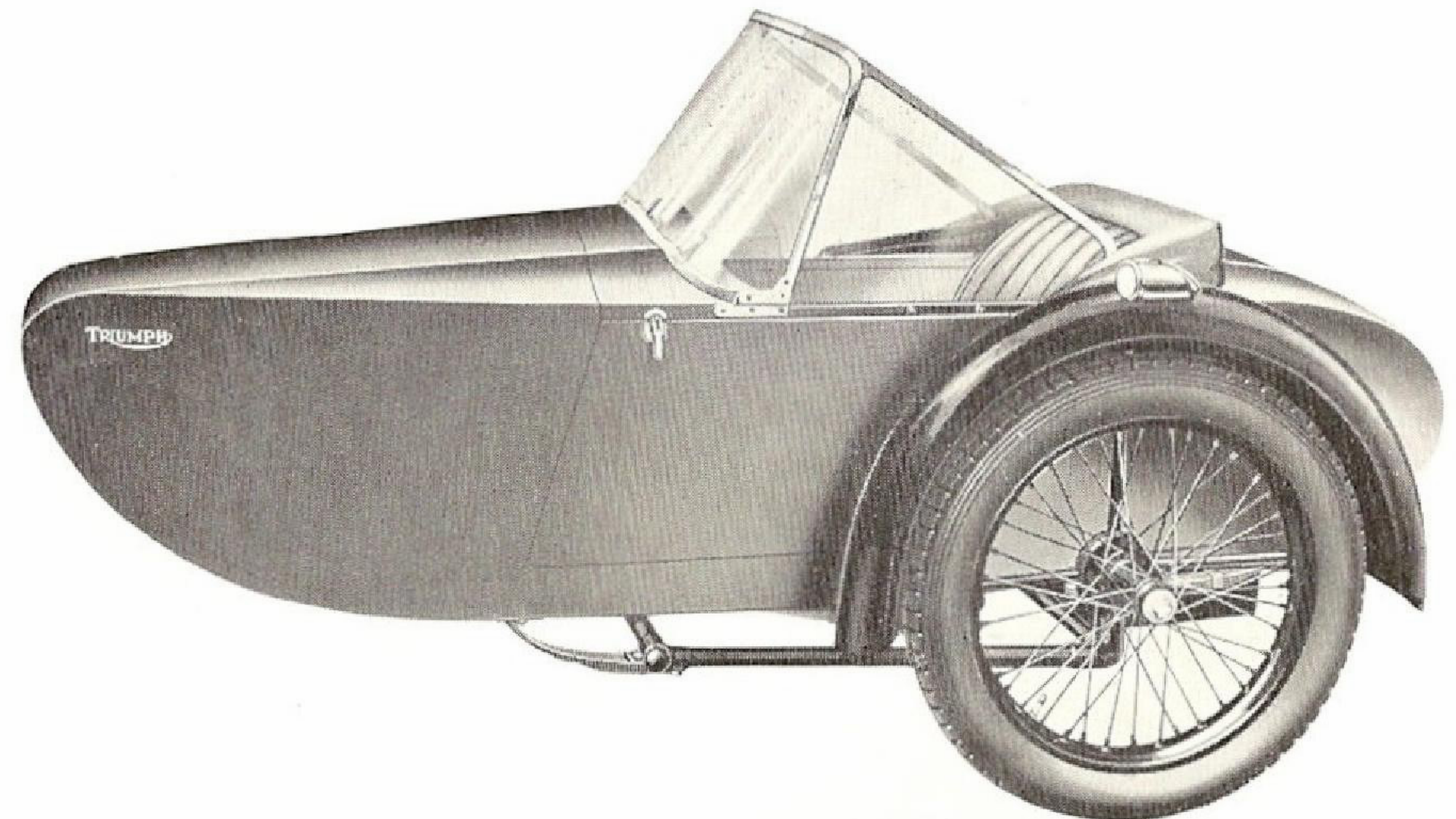

## Model AS/37

A delightfully designed Sun Saloon Sidecar on launch lines. Very light but strongly constructed with ample room for the tallest passenger. Specially constructed to exclude all possibilities of rain or draughts entering the body. Chassis built of heavy gauge weldless tubular steel with brazed-up lugs. Well sprung. Fittings include, quickly manipulated roll-back sun roof. Best quality leather cloth upholstery, deeply sprung. Hinged rear deck ventilator. Heavy gauge celluloid windows. Colours: Plum and Black or Blue and Silver.

PRICE (complete with electric lamp) ....

**£21-10-0**

Child's Dickey Seat 25/- extra.

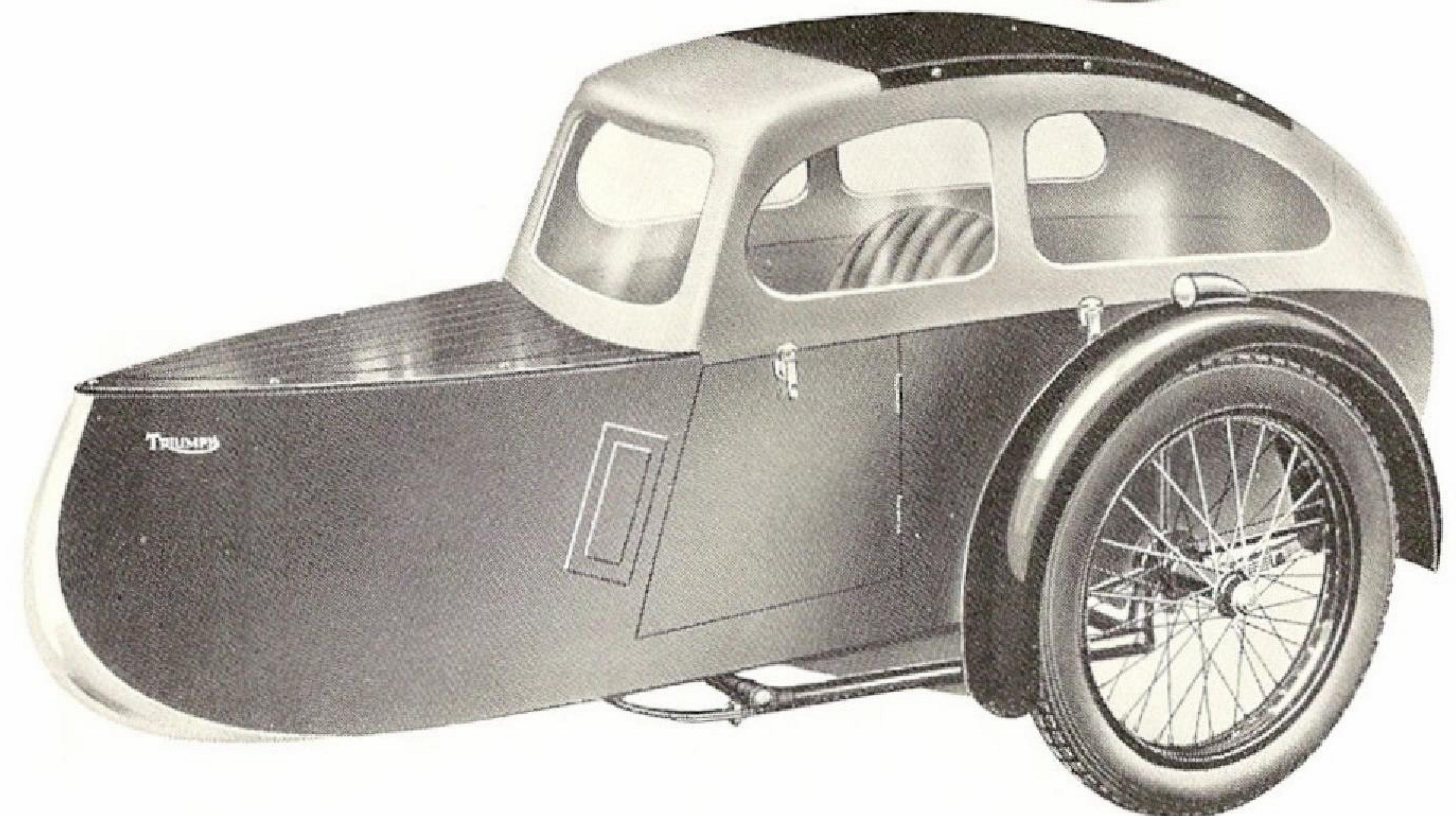

ALL TRIUMPH SIDECAR CHASSIS ARE ATTACHED TO THE MACHINE BY MEANS OF SELF-ALIGNING BALL JOINTS



# OUTSTANDING TRIUMPH FEATURES

FOR 1937 THE WHOLE RANGE HAS BEEN EXTENSIVELY RE-DESIGNED. Careful research and experiment have enabled really large savings in weight to be effected without any sacrifice in strength and this has, of course, resulted in a further step forward in performance. Even the largest models now have a "handiness"—for want of a better term—which comes, as a revelation, to those who are new to them.

## ENGINE REFINEMENTS

The Power units have been the subject of further development. All are now of the single-port type and have fully enclosed and automatically lubricated valve gear. Whilst the high power output of the Tiger engines has been maintained, and even improved on, a considerable advance in mechanical silence and longevity has been achieved. That valuable feature accessibility has had further attention and although adjustments are but rarely called for, the new tappet location—at the base of the push rods in the O.H.V. models—and the latest carburetter with horizontal mixing chamber on the 500 c.c. engines are notable improvements.

## IMPROVED TRANSMISSION

A new Triumph gearbox has been developed which is completely silent on all four ratios and incorporates a fully enclosed and patented, positive stop, foot operated change mechanism which is outstandingly

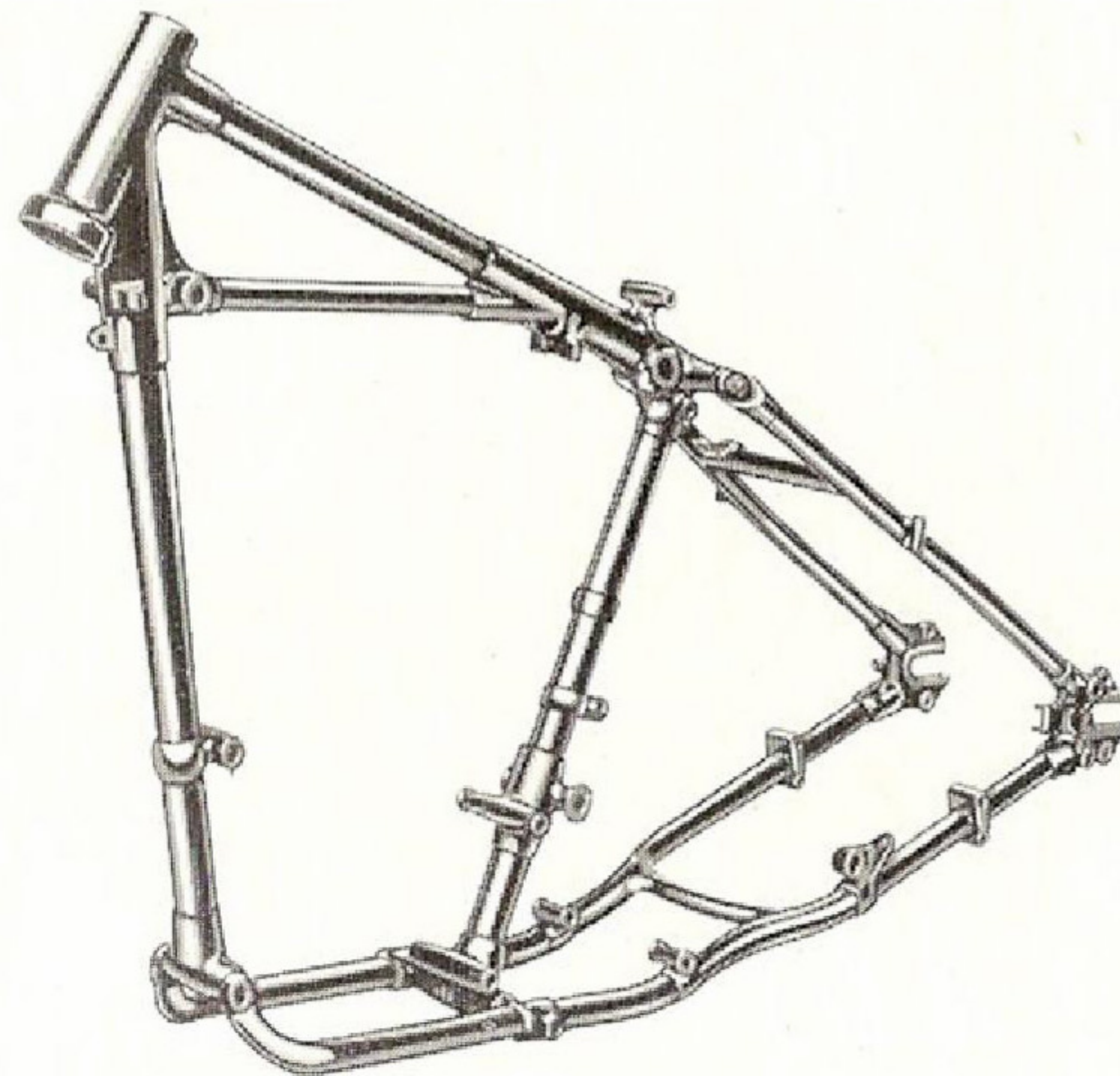
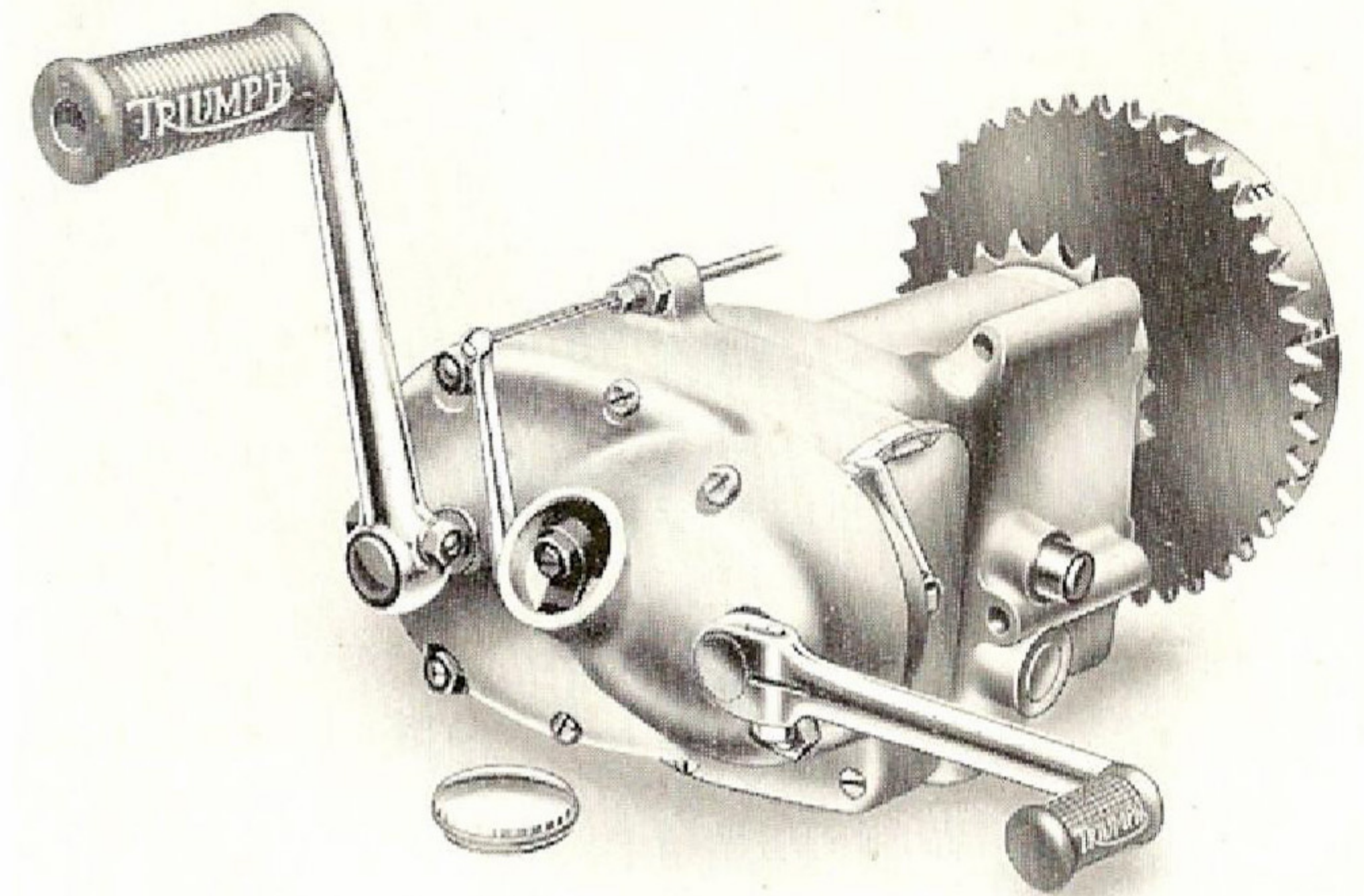

easy to operate. Neutral can always be found with certainty and the range of movement of the pedal is short. A new clutch is operated by a fully enclosed mechanism and the exterior of the gearbox—like all other aluminium parts—is smooth and highly polished. The highest quality nickel chrome alloy steel is used for the shafts and gears. The handsome polished aluminium oil-bath primary chain case which was a prominent feature of the 1936 Tigers has been retained in an improved form and provision is included to prevent internal condensation taking place.

## STRENGTH WITH LIGHTNESS

A particularly important development is the introduction of an entirely new frame which marks a notable advance in every way over previous designs. Great strength and torsional stiffness have been



successfully combined with low weight. Of the cradle type, it is simple and robust and the single front down tube on the larger models is of tapered formation thus giving the maximum of strength at the head without unnecessary weight. For use with this frame new Triumph front forks have been developed. These are built up of tapered tubes brazed into massive bridges and here again a saving in weight has been effected without sacrifice of strength or rigidity. Rebound dampers of an improved design are standardised and are now situated on the lower bridge.

## RE-DESIGNED BRAKES

On the larger models the new Triumph wheels are used. In these all the spokes are of approximately equal length and take both braking and transmission stresses. The ribbed brake drums of a special alloy are detachable. Throughout the range new 7" diameter brakes are used and these not only provide great retarding power but are capable of giving really long service under arduous conditions before relining becomes necessary. Accessible finger adjusters are provided, that for the front brake being readily accessible to the rider whilst he is in the saddle.

## ENHANCED PERFORMANCE

Greatly improved steering and road holding are immediately evident on the new machines and these permit of the highest speeds being maintained in comfort and safety. The increased liveliness resulting from the enhanced power to weight ratio is moreover very marked and will be specially appreciated by the sporting rider.

## COMPLETE EQUIPMENT

Resiliently mounted handlebars are a further refinement and these together with the saddle, footrests and all controls are fully adjustable so that a comfortable riding position is easily obtainable.

Equipment is complete and Lucas 6 volt Magdyno lighting and ignition with automatic voltage control, a large headlamp and an electric horn are standardised. A large and water tight welded steel toolbox with rubber lining and an illuminated tank top instrument panel carrying an oil gauge, ammeter and lighting switch are other features. The new petrol tanks combine increased capacity with a graceful streamlined contour.

## TRIUMPH FINISH

The standard of finish throughout is in accordance with the best Triumph traditions. All bright parts, including the petrol tank, are heavily chromium plated, the frame and other parts being finished in 3 coats of the best black enamel.

For further details of the distinctive new de luxe and Tiger finishes see specifications on pages 2 and 6.

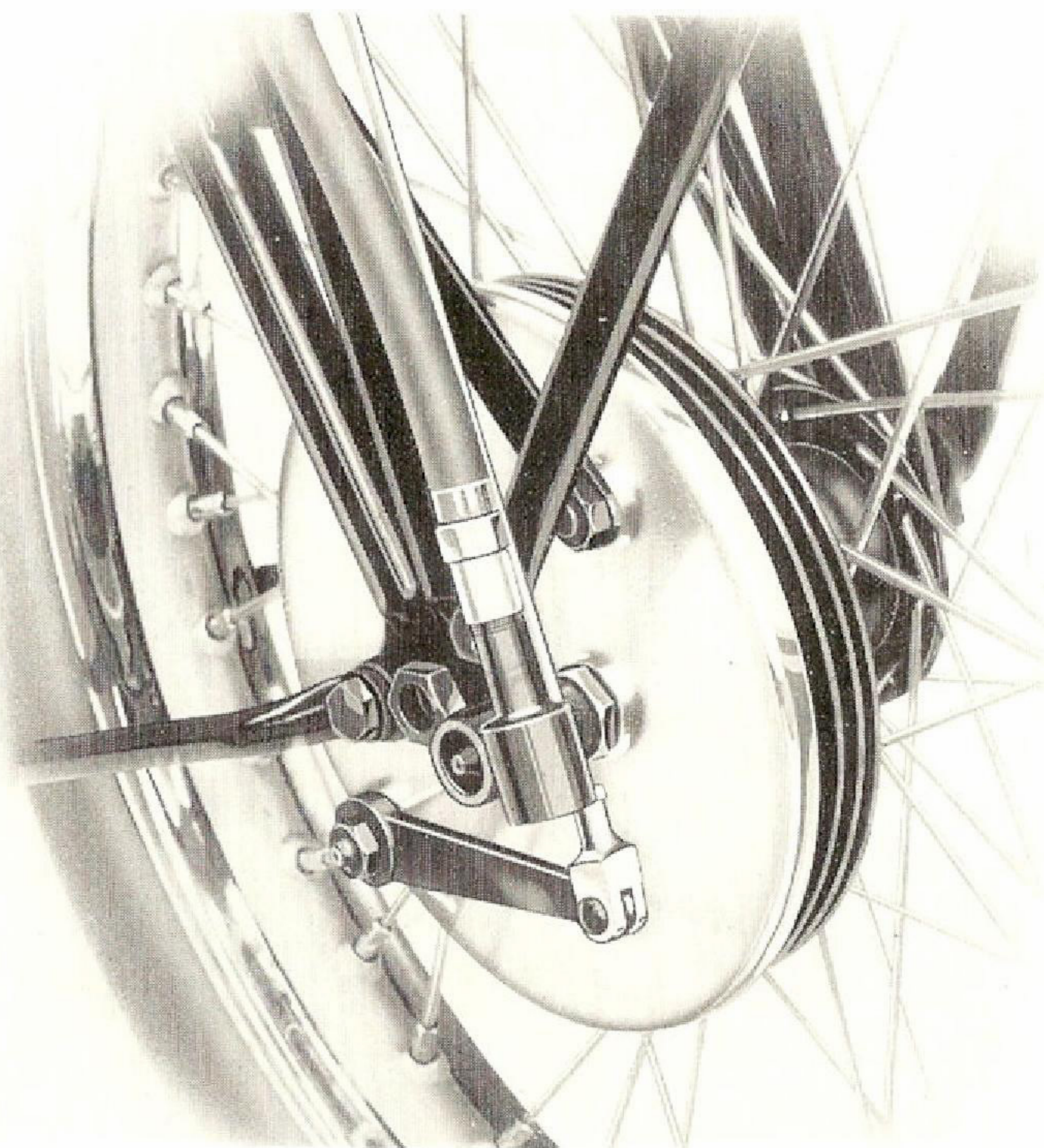



# TIGER ENGINE POWER CURVES

HEENAN AND FROUDE

BRAKE TEST

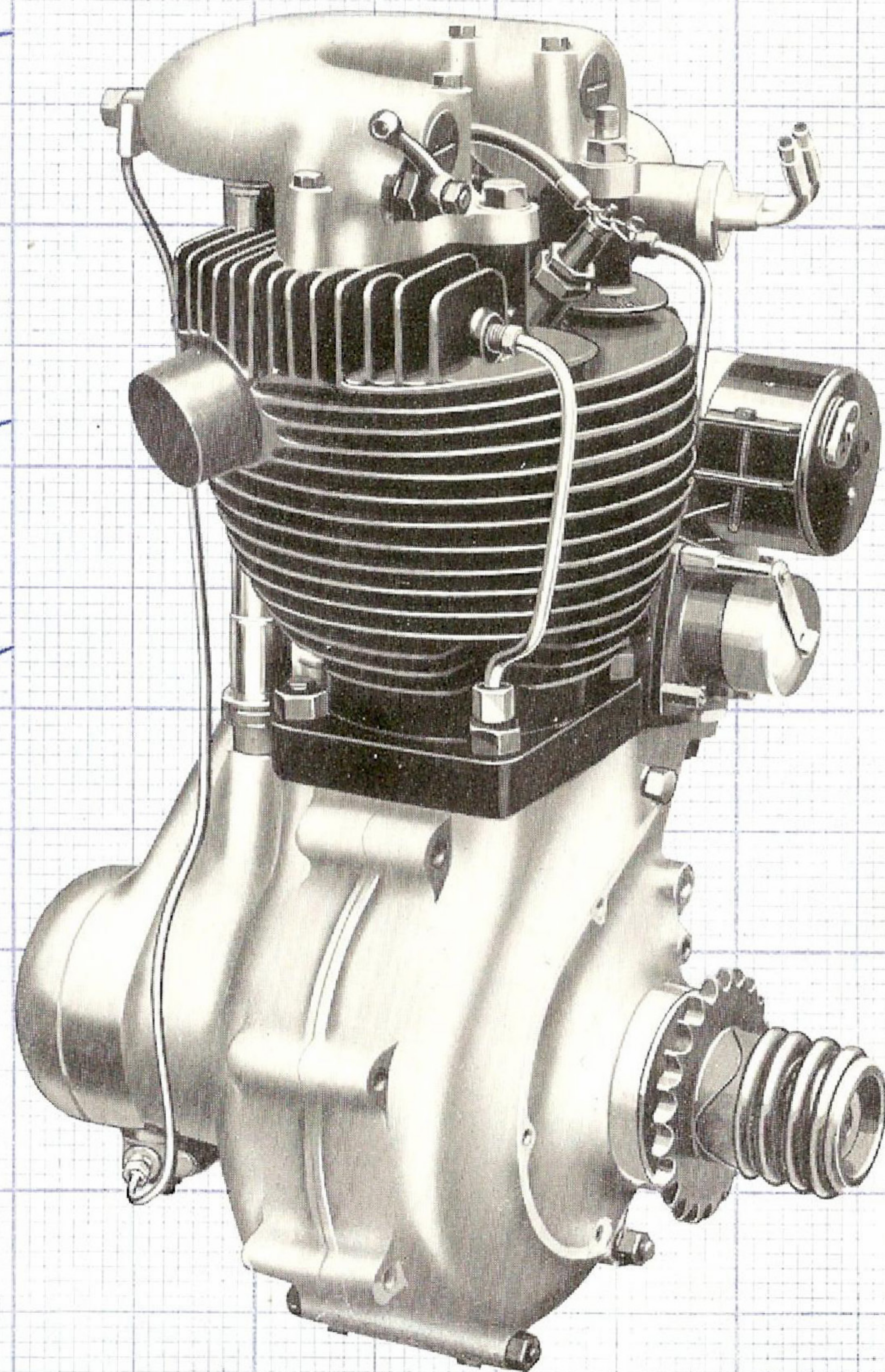
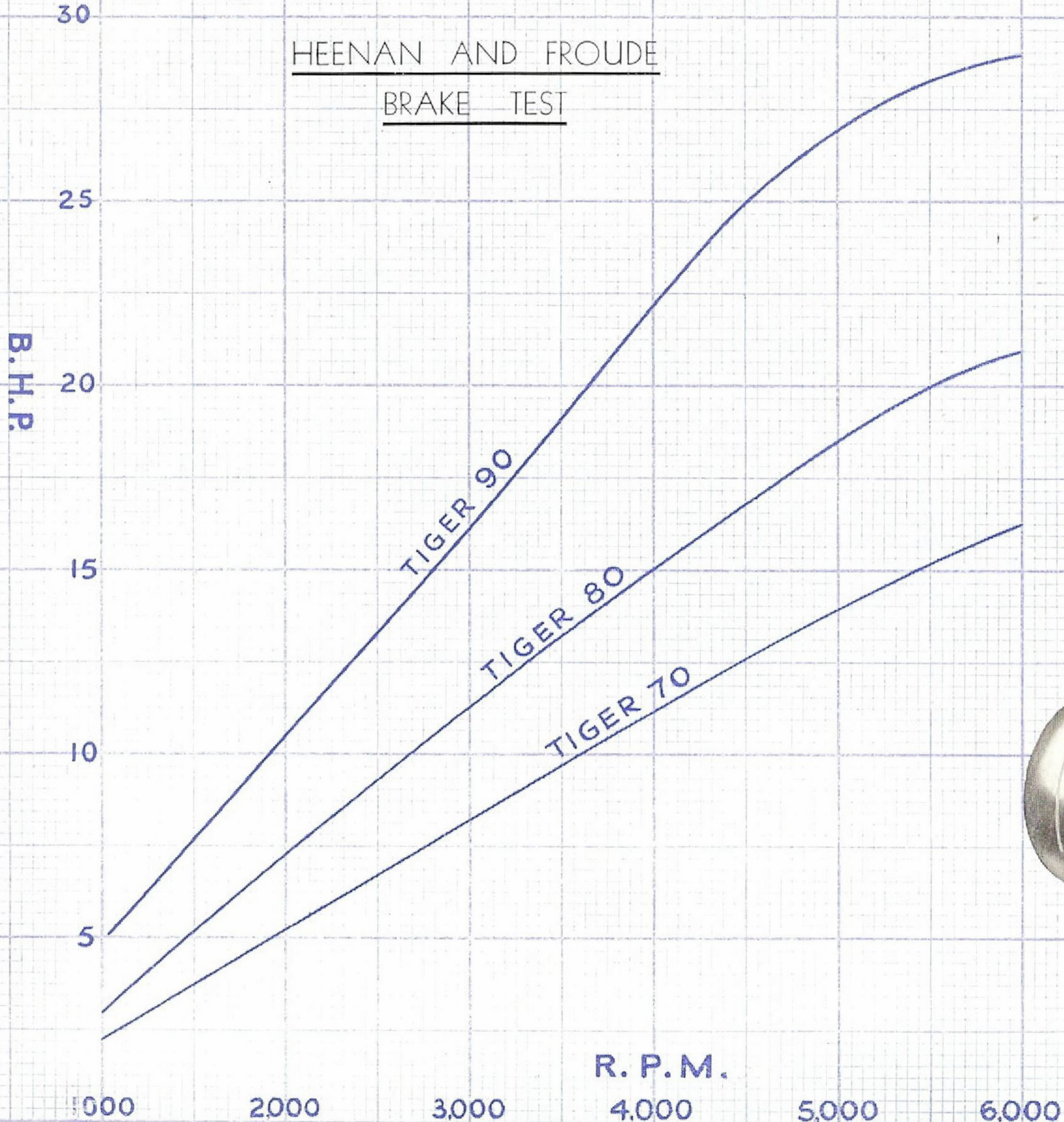



# TECHNICAL INFORMATION

MODEL	T90	T80	T70	6S	5H	3S	3H	2H
Bore and Stroke ... mm.	84 × 89	70 × 89	63 × 80	84 × 108	84 × 89	70 × 89	70 × 89	63 × 80
Cylinder Capacity ... c.c.	497	349	249	597	497	349	349	249
Compression ratio ...	7.08 : 1	7.5 : 1	7.7 : 1	5.6 : 1	6 : 1	5.3 : 1	6.7 : 1	6.92 : 1
B.H.P. @ R.P.M. ...	28.29 @ 5,800	20 @ 5,700	16 @ 5,800	18 @ 4,800	23 @ 5,000	12 @ 4,800	17 @ 5,200	13 @ 5,200
Engine revs.: Top gear @ 10 m.p.h. Solo ...	618	676	750	618	618	788	711	788
Carburettor Main Jet ...	200	150	110	170	200	120	150	110
Engine Sprocket No. of teeth Solo	23	21	19	23	23	18	20	18
Clutch diameter ...	6"	6"	6"	6"	6"	6"	6"	6"
Plates : Number	4 Driving 5 Driven	3 Driving 4 Driven	3 Driving 4 Driven	4 Driving 5 Driven	4 Driving 5 Driven	3 Driving 4 Driven	3 Driving 4 Driven	3 Driving 4 Driven
Friction Material ...	Cork	Cork	Cork	Cork	Cork	Cork	Cork	Cork
Clutch Sprocket No. of teeth ...	43	43	43	43	43	43	43	43
Gearbox Sprocket " " ...	18	18	18	18	18	18	18	18
Gear ratios: Top Solo ...	4.78	5.23	5.8	4.78	4.78	6.1	5.5	6.1
" " Third " ...	5.75	6.28	6.95	5.75	5.75	7.3	6.6	7.3
" " Second " ...	8.26	9.05	10.0	8.26	8.26	10.5	9.5	10.5
" " Low " ...	12.1	13.3	14.7	12.1	12.1	15.5	14.0	15.5
" " Top Sidecar ...	5.23	—	—	5.23	5.23	—	—	—
" " Third " ...	6.28	—	—	6.28	6.28	—	—	—
" " Second " ...	9.05	—	—	9.05	9.05	—	—	—
" " Low " ...	13.3	—	—	13.3	13.3	—	—	—
Rear Wheel Sprocket No. of teeth	46	46	46	46	46	46	46	46
Rear Chain Solo ...	5/8" × .375"	5/8" × .250"	1/2" × .305"	5/8" × .375"	5/8" × .375"	5/8" × .250"	5/8" × .250"	1/2" × .305"
" " No. of pitches Solo	94	90	101	94	94	90	90	101
" " " " Sidecar	94	—	—	94	94	—	—	—
Front Chain ...	1/2" × .305"	1/2" × .305"	1/2" × .305"	1/2" × .305"	1/2" × .305"	1/2" × .305"	1/2" × .305"	1/2" × .305"
" " No. of pitches Solo	81	76	73	81	81	76	76	73
" " " " Sidecar	79	—	—	79	79	—	—	—
Brake Drums :	7" × 1 1/8" F	7" × 1" F	7" × 1" F	7" × 1 1/8" F	7" × 1 1/8" F	7" × 1" F	7" × 1" F	7" × 1" F
diameter and width	7" × 1 1/8" R	7" × 1 1/8" R	7" × 1 1/8" R	7" × 1 1/8" R	7" × 1 1/8" R	7" × 1 1/8" R	7" × 1 1/8" R	7" × 1 1/8" R
Tyres Dunlop Universal	26" × 3" F	26" × 3" F	26" × 3" F	26" × 3.25" F	26" × 3.25" F	26" × 3.25" F	26" × 3.25" F	26" × 3" F
Dunlop Ribbed to "Tiger"	26" × 3.5" R	26" × 3.25" R	26" × 3.25" R	26" × 3.25" R	26" × 3.25" R	26" × 3.25" R	26" × 3.25" R	26" × 3.25" R
front wheels ...								
Saddle Height ...	27 3/4	27	27	27 3/4	27 3/4	27	27	27
Wheelbase ...	54"	52 1/2"	52 1/2"	54"	54"	52 1/2"	52 1/2"	52 1/2"
Overall length ...	84"	82"	82"	84"	84"	82"	82"	82"
Overall width ...	30"	30"	30"	30"	30"	30"	30"	30"
Ground Clearance ...	5"	5 1/2"	5 1/4"	5"	5"	5 1/2"	5 1/2"	5 1/4"
Weight, fully equipped lbs.	365	320	310	360	365	315	320	310

## MOTOR CYCLE EXTRAS

Rear Stop Light	5 0	Pillion Footrests	7 6	Dunlop Competition Tyres		"Straight through" exhaust	
Smith Chronometric Speedometer 80 m.p.h. Trip Type	2 10 0	Rear Carrier	5 0	27 in. × 4 in. (Rear) extra	15 6	pipe	6 6
Smith Chronometric Speedometer 120 m.p.h. Trip Type	2 16 0	26 × 3.5 Dunlop Tyres over 26 in. × 3.25 in. extra	9 6	Crankcase Shield	10 0	Chrome rims and Enamelled centres where not standard	
As above 5 in. dial	5 5 0	Dunlop Competition Tyres 27 in. × 3 in. (Front) extra	8 0	Prop Stand	10 0		
				Pillion Seat	12 6		
				Quickly detachable rear wheel	2 0 0	per pair	1 0 0



## COPY OF GUARANTEE GIVEN TO TRIUMPH DEALERS

WE do not appoint agents for the sale of our motor cycles or other goods. We assign to Motor Cycle Dealers who carry on business on their own account, areas in which they have the exclusive or other right to sell goods purchased by them from us. A Dealer purchasing from us or a Sub-dealer purchasing from him may assign to his purchaser the benefit of the guarantee printed below. Any such dealer is not authorised to advertise, incur any debts, or transact any business whatsoever on our account; nor is he authorised, so as to bind us, to give any warranty or make any representation or make or agree to any condition on our behalf.

We give the following guarantee with our motor cycles, motor cycle combinations and sidecars, which is given in place of any conditions, warranties or liabilities whatsoever, implied by law, implied at the place of manufacture and/or at the place of sale, all such implied conditions, warranties, and liabilities being in all cases excluded. Any statement, description, condition or representation contained in our catalogue, or in any advertisement, leaflet or other publications shall not be construed as enlarging, varying, or overriding this guarantee. In the case of machines which have been used for "hiring out" purposes, or any motor cycle and/or sidecar used for any dirt track, cinder or grass track, racing or competitions (or any competition of any kind within an enclosure for which a charge is made for admission to take part in or view the competition), or from which our trade mark or manufacturing number has been removed, no warranty or condition of any kind is given or is to be implied.

We guarantee, subject to the conditions mentioned below, that all precautions which are usual and reasonable have been taken by us to secure excellence of materials and workmanship, but this guarantee is to extend and be in force for six months only from date of delivery and damages for which we make ourselves responsible under this guarantee are limited to the free supply of a new part in exchange for the part of the motor cycle, motor cycle combination or sidecar which may have proved defective. We do not undertake to replace or refix or bear the cost of replacing or refixing, such new part in the motor cycle, motor cycle combination or sidecar. We undertake, subject to the conditions mentioned below, to make good at any time within six months any defects in these respects. As motor cycles and motor cycle combinations are easily liable to derangement by neglect or misuse, this guarantee does not apply to defects caused by wear and tear, misuse or neglect.

The term "misuse" shall include amongst others the following acts.

1. The attaching of a sidecar to a motor cycle in a manner calculated to cause damage or to render the latter unsafe when ridden.
2. The use of a motor cycle or of a motor cycle and sidecar combined, when carrying more persons or a greater weight than that for which the machine was designed by the manufacturers.
3. The attaching of a sidecar to a motor cycle by any form of attachment not provided or supplied or approved by the manufacturers, or to a motor cycle which is not designed for such use.
4. The attaching of a sidecar by any means to a motor cycle not recommended by the manufacturers for such a purpose.
5. The alteration to the silencing system as supplied by the manufacturer, and/or the partial or complete removal of any part or parts of the silencing system.

Any motor cycle or motor cycle combination or sidecar sent to us to be plated, enamelled, or repaired will be repaired upon the following conditions, *i.e.*, we guarantee that all precautions which are usual and reasonable have been taken by us to secure excellence of materials and workmanship, such guarantee to extend and be in force for three months, only from the time such work shall have been executed or until the expiration of the six months above referred to, and this guarantee is in lieu and in exclusion of any common law or statute, warranty, or condition and the damages recoverable are limited to the cost of any further work which may be necessary to amend and make good the work found to be defective.

### CONDITIONS OF GUARANTEE

If a defective part should be found in our motor cycles, motor cycle combinations or sidecars, or in any part supplied by way of exchange before referred to, it must be sent to us CARRIAGE PAID, and accompanied by an intimation from the sender that he desires to have it repaired or exchanged free of charge under our guarantee, and he must also furnish us at the same time with the number of the machine, the name of the Dealer from whom he purchased, and the date of purchase, or the date when the alleged defective part was exchanged as the case may be.

Failing compliance with the above, no notice will be taken of anything which may arrive, but such articles will lie here AT THE RISK OF THE SENDERS.

We guarantee only those machines which are bought either direct from us or from a Dealer, who has purchased direct from us, or from a Sub-dealer who has purchased from him, and under no other condition.

We do not guarantee the specialities of other firms such as tyres, saddles, chains, lamps, etc., nor do we guarantee any component parts supplied to the order of the purchaser differing from our standard specifications supplied with our motor cycles, motor cycle combinations, sidecars or otherwise.

### TERMS OF BUSINESS

**PAYMENT.** In all cases where we have no ledger account, an invoice will be submitted to intending purchasers on payment of which goods will be forwarded, or approved references must be given.

**INSURANCE.** Motor Cycles and Sidecars, when forwarded per Passenger Train to any part of Great Britain or Northern Ireland, are consigned, unless otherwise instructed by the purchaser, at lowest rates, *i.e.*, consignee's risk, but in order that the consignee shall be relieved of all troublesome negotiations should breakage or damage occur, all new complete machines forwarded by us in the above manner are covered by Insurance against damage in transit, theft, and pilferage up to 75 per cent. of the total loss, customers should, therefore, notify the Company immediately in respect of any damage or loss. It is understood that the Company only act as agents between the purchaser and the Insurance Company, and no responsibility attaches to the Company in case of non-compliance of the Insurance Company with the claim of the purchaser.

Motor Cycles and Sidecars, when forwarded per Goods Train, are consigned at Railway Company's risk, and in case of damage, all claims should be addressed to the Carriers.

The above arrangement does not apply to repairs or spare parts.

We reserve the right to modify or deviate from specifications in minor details.

All goods are sold by us subject to the limited warranty fully set out above.

Packing Crates are charged for, but are returnable.

### SPARE PARTS AND REPLACEMENTS

WHEN ORDERING SPARE PARTS OR REPLACEMENTS, please specify catalogue number or code word quoted in Spare Parts Catalogue. If a Spare Parts Catalogue is not available it is advisable, if possible, to send pattern, so as to ensure the order being executed correctly. If this cannot be done, let us have the number of the machine, also the number of the engine. Catalogue of Spare Parts on application, price 1/6 (post free).

**REPAIRS.** Repairs are charged at net cash price in all cases. Machines or parts for repair must be forwarded carriage paid to the Works, with the sender's name attached. The despatch should be promptly advised by SEPARATE POST, and full instructions for repair enclosed, otherwise unnecessary delay and annoyance are often caused.

Customers having no account with us should not fail to send remittance with order: remittance must cover postage if goods ordered are under £1 in value.

When making enquiries respecting any part or repair, PLEASE QUOTE OUR ORDER NUMBERS IN EVERY CASE, otherwise it is difficult to trace the matter.

When sending machines to our Works for repair, it is advisable to remove all spares and accessories, as we cannot be responsible if any of these are missing when the machine is returned.



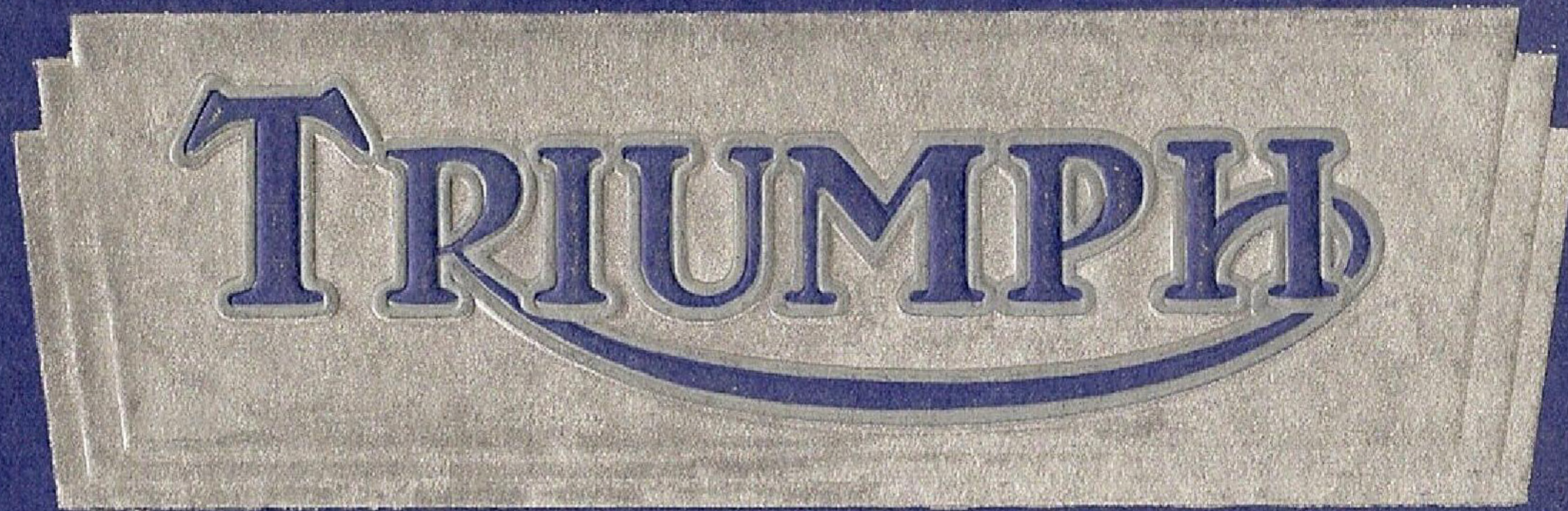

*A catalogue of famous Motor Cycles*